

FYP1010DN

Schottky Barrier Rectifier

- Low forward voltage drop
- High frequency properties and switching speed
- Guard ring for over-voltage protection

Applications

- Switched mode power supply
- Freewheeling diodes

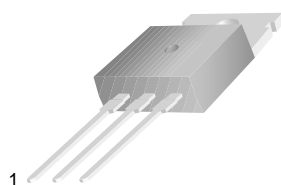

TO220 (None Jedec type)

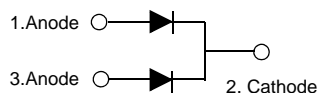

Absolute Maximum Ratings * $T_C=25^{\circ}\text{C}$ unless otherwise noted

Symbol	Parameter	Value	Units
V_{RRM}	Maximum Repetitive Reverse Voltage	100	V
V_R	Maximum DC Reverse Voltage	100	V
$I_{F(AV)}$	Average Rectified Forward Current @ $T_C = 135^{\circ}\text{C}$	10	A
I_{FSM}	Non-repetitive Peak Surge Current (per diode) 60Hz Single Half-Sine Wave	100	A
T_J, T_{STG}	Operating Junction and Storage Temperature	-65 to +150	$^{\circ}\text{C}$

Thermal Characteristics

Symbol	Parameter	Value	Units
$R_{\theta JC}$	Maximum Thermal Resistance, Junction to Case (per diode)	2.5	$^{\circ}\text{C}/\text{W}$

Electrical Characteristics (per diode)

Symbol	Parameter	Value	Units
$V_{FM} *$	Maximum Instantaneous Forward Voltage	$T_C = 25^{\circ}\text{C}$	V
		$T_C = 125^{\circ}\text{C}$	
		$T_C = 25^{\circ}\text{C}$	
		$T_C = 125^{\circ}\text{C}$	
$I_{RM} *$	Maximum Instantaneous Reverse Current @ rated V_R	$T_C = 25^{\circ}\text{C}$	mA
		$T_C = 125^{\circ}\text{C}$	

* Pulse Test: Pulse Width=300 μs , Duty Cycle=2%

Typical Performance Characteristics

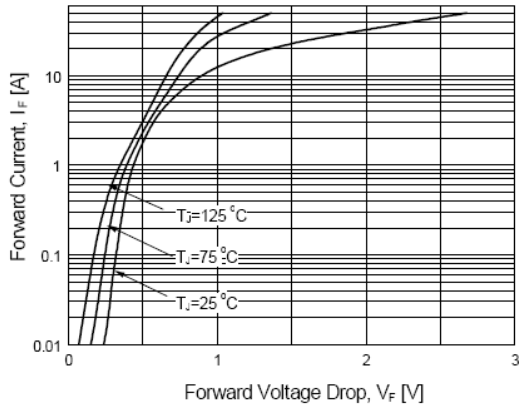

Figure 1. Typical Forward Voltage Characteristics (per diode)

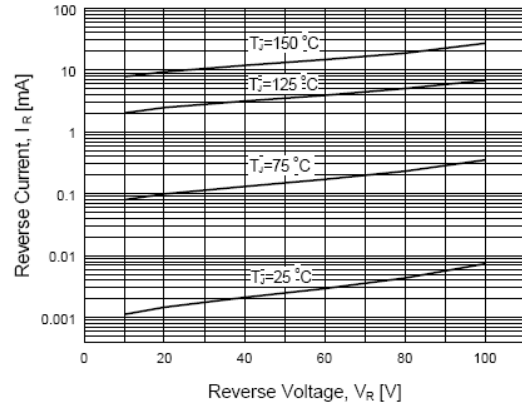

Figure 2. Typical Reverse Current vs. Reverse Voltage (per diode)

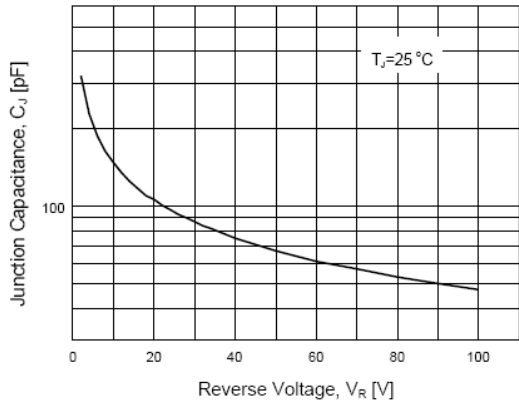

Figure 3. Typical Junction Capacitance (per diode)

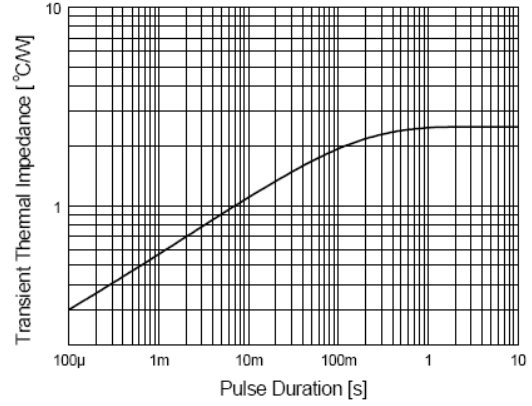

Figure 4. Thermal Impedance Characteristics (per diode)

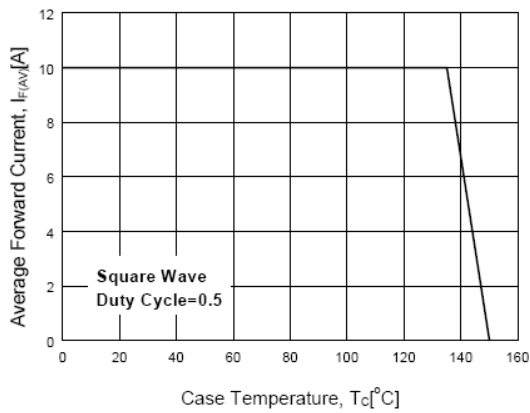

Figure 5. Forward Current Derating Curve

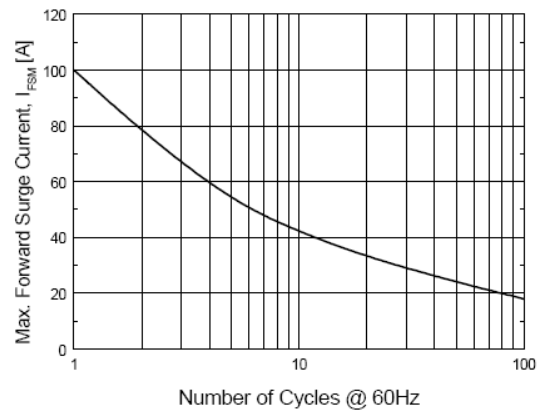
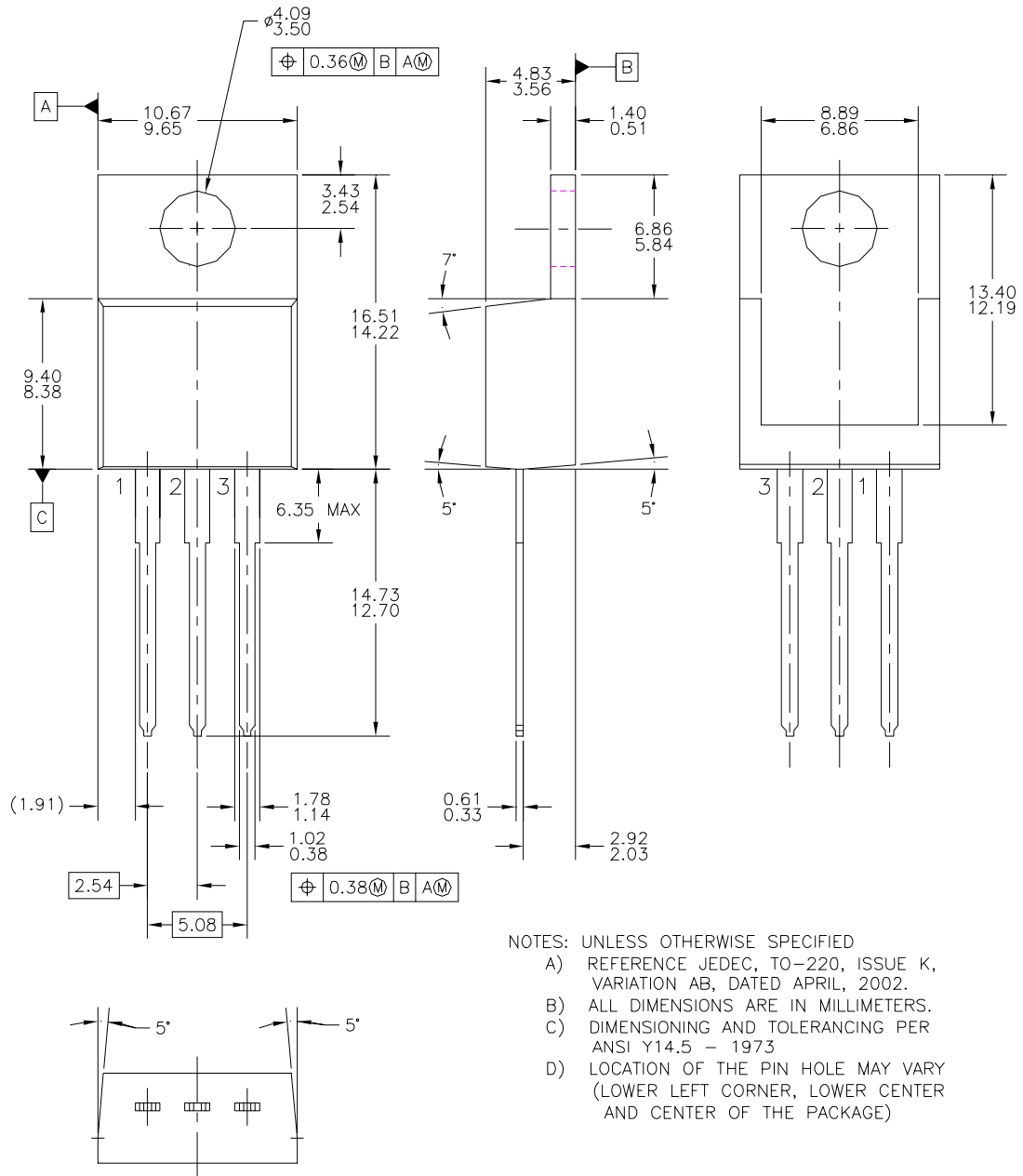

Figure 6. Non-Repetitive Surge Current (per diode)

Package Dimensions

TO-220



TO220B03REVD

Dimensions in Millimeters



FAIRCHILD SEMICONDUCTOR TRADEMARKS

The following are registered and unregistered trademarks Fairchild Semiconductor owns or is authorized to use and is not intended to be an exhaustive list of all such trademarks.

ACE ^x ™	FACT Quiet Series™	OCX™	SILENT SWITCHER®	UniFET™
ActiveArray™	GlobalOptoisolator™	OCXPro™	SMART START™	VCX™
Bottomless™	GTO™	OPTOLOGIC®	SPM™	Wire™
Build it Now™	HiSeC™	OPTOPLANAR™	Stealth™	
CoolFET™	l ² C™	PACMAN™	SuperFET™	
CROSSVOLT™	i-Lo™	POPT™	SuperSOT™-3	
DOME™	ImpliedDisconnect™	Power247™	SuperSOT™-6	
EcoSPARK™	IntelliMAX™	PowerEdge™	SuperSOT™-8	
E ² CMOS™	ISOPLANAR™	PowerSaver™	SyncFET™	
EnSigna™	LittleFET™	PowerTrench®	TCM™	
FACT®	MICROCOUPLER™	QFET®	TinyBoost™	
FAST®	MicroFET™	QS™	TinyBuck™	
FAST _r ™	MicroPak™	QT Optoelectronics™	TinyPWM™	
FPS™	MICROWIRE™	Quiet Series™	TinyPower™	
FRFET™	MSX™	RapidConfigure™	TinyLogic®	
	MSXPro™	RapidConnect™	TINYOPTO™	
Across the board. Around the world.™		μSerDes™	TruTranslation™	
The Power Franchise®		ScalarPump™	UHC®	
Programmable Active Droop™				

DISCLAIMER

FAIRCHILD SEMICONDUCTOR RESERVES THE RIGHT TO MAKE CHANGES WITHOUT FURTHER NOTICE TO ANY PRODUCTS HEREIN TO IMPROVE RELIABILITY, FUNCTION OR DESIGN. FAIRCHILD DOES NOT ASSUME ANY LIABILITY ARISING OUT OF THE APPLICATION OR USE OF ANY PRODUCT OR CIRCUIT DESCRIBED HEREIN; NEITHER DOES IT CONVEY ANY LICENSE UNDER ITS PATENT RIGHTS, NOR THE RIGHTS OF OTHERS. THESE SPECIFICATIONS DO NOT EXPAND THE TERMS OF FAIRCHILD'S WORLDWIDE TERMS AND CONDITIONS, SPECIFICALLY THE WARRANTY THEREIN, WHICH COVERS THESE PRODUCTS.

LIFE SUPPORT POLICY

FAIRCHILD'S PRODUCTS ARE NOT AUTHORIZED FOR USE AS CRITICAL COMPONENTS IN LIFE SUPPORT DEVICES OR SYSTEMS WITHOUT THE EXPRESS WRITTEN APPROVAL OF FAIRCHILD SEMICONDUCTOR CORPORATION.

As used herein:

- Life support devices or systems are devices or systems which, (a) are intended for surgical implant into the body, or (b) support or sustain life, or (c) whose failure to perform when properly used in accordance with instructions for use provided in the labeling, can be reasonably expected to result in significant injury to the user.
- A critical component is any component of a life support device or system whose failure to perform can be reasonably expected to cause the failure of the life support device or system, or to affect its safety or effectiveness.

PRODUCT STATUS DEFINITIONS

Definition of Terms

Datasheet Identification	Product Status	Definition
Advance Information	Formative or In Design	This datasheet contains the design specifications for product development. Specifications may change in any manner without notice.
Preliminary	First Production	This datasheet contains preliminary data, and supplementary data will be published at a later date. Fairchild Semiconductor reserves the right to make changes at any time without notice in order to improve design.
No Identification Needed	Full Production	This datasheet contains final specifications. Fairchild Semiconductor reserves the right to make changes at any time without notice in order to improve design.
Obsolete	Not In Production	This datasheet contains specifications on a product that has been discontinued by Fairchild semiconductor. The datasheet is printed for reference information only.